



R32變頻淨冷
窗口式冷氣機

遙控器 操作說明書

型號:

RC-TS7UV

RC-TS9UV

RC-TS12UV

RC-TS18UV

RC-TS24UV

重要提示:

感謝您購買我們的冷氣機。在操作您的新冷氣機之前，請仔細閱讀本說明書。請務必保存本說明書以供將來參考。

目 錄

規格表	2
遙控器上按鈕的作用	3
顯示屏的指示	6
使用方法	7
遙控器的處理	12

注意：

遙控器按鍵設計可能與實際購買的樣式略有不同，以實際形狀為準。

如果該產品沒有此功能，按遙控器上的相關按鈕時，不會發生相應的操作。

規格表

額定電壓	3.0V (兩節 AAA 乾電池)
信號到達距離	8 米
使用條件	-5°C ~ 60°C



遙控器上按鈕的作用

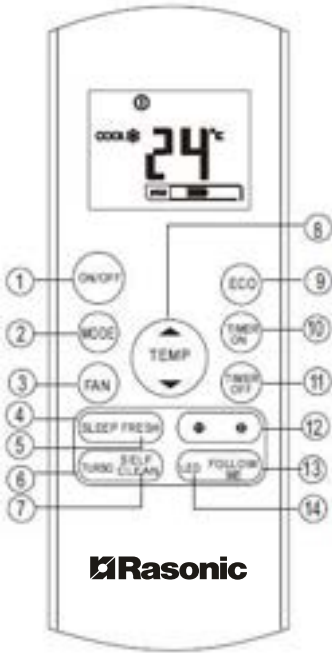

- ①**開/關插鈕(ON/OFF)**: 按此按鈕，冷氣機便開始運轉；再按此按鈕，冷氣機便停止運。
- ②**模式選擇按鈕 (MODE)**: 每按一次按鈕運行模式就按下列依次變化：



風速選擇按鈕(FAN):用於選擇風速，每按一次按鈕，風速就按下述依次變化：

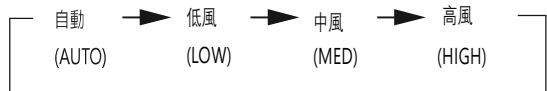

注意：在抽濕模式時無法調整風速。

- ④**睡眠按鈕(SLEEP)**:按此按鈕，選擇進入睡眠運行模式。

注意：只有在製冷模式下可應用此模式。當產品在睡眠模式下運行時，如果按下任意 MODE, FAN ON/OFF 按鈕，則會取消該功能。

- ⑤**清淨按鈕(FRESH)**:按下此按鈕，啟動UV,有助殺滅空氣中細菌及病毒。

增強模式按鈕(TURBO):按下此按鈕，產品會在條件允許的最大頻率下運行，使設備在最短的時間內達到預設溫度。

⑦**自動清潔按鈕 (SELF CLEAN)** (只適用於**RC-TS7UV,RC-TS9UV及RC-TS12UV**)

空氣中的細菌會在設備熱交換器周圍凝結的水氣中滋生。

按自動清潔(SELF CLEAN)按鈕，您的設備將自動清潔。清潔後，設備將自動關閉。在清潔中按自動清潔(SELF CLEAN)按鈕將取消操作並關閉設備。您可以根據需要隨時使用自動清潔。注意：您只能在 COOL 或 DRY 模式下啟動此功能。

⑧**提溫按鈕 (TEMP ▲)** :按此按鈕可將室內溫度設置以 1°C 為增量增加到最高 30°C。

降溫按鈕 (TEMP ▼) :按下此按鈕將室內溫度設置以 1°C 減量降低到最低 17°C 。注意：溫度控制不適用於在“風速 FAN”模式下使用。

⑨**節能按鈕 (ECO)**：用於進入節能模式。 在製冷模式下，按這個按鈕，遙控器將自動調整溫度到 24° C，風扇速度為自動，以節省能源（但只有在設定溫度低於 24° C時）。 如果設定溫度在24° C和 30° C之間，按下ECO 按鈕，

風扇速度將變為自動，設定溫度將保持不變。

注意：

1、按下 TURBO 和 SLEEP 按鈕，轉換模式或將設定溫度調至低於 24°C，將停止 ECO 操作。

2、在 ECO 操作下，設定溫度應在 24°C或以上,但這可能會導致製冷不足。如果你感到不舒服，只需再次按下 ECO 按鈕即可停止。

⑩**定時開機按鈕 (TIMER ON)**：按此按鈕，開啟自動啟動時間順序。 每按一次，將以 30 分鐘的增量增加自動定時設置。 當設置時間顯示

“10 .0”，每次按下將增加自動定時設置 60 分鐘增量。要取消自動定時程序，只需將自動啟動時間調整為 “0.0 “。

⑪**定時停關按鈕 (TIMER OFF)**：按此按鈕，啟動自動關閉時間順序。 每按一次，將以 30 分鐘的增量增加自動定時設置。 當設置時間顯示 “10 .0”，每次按下將增加自動定時設置 1小時增量。 要取消自動定時程序，只需調整自動關機時間至 “0.0 “。

擺動按鈕(◀▶)：

用於停止或啟動垂直送風葉運動，並設定所需的左/右氣流方向。每按一次，垂直送風葉的角度就會改變6度。如果按住這個按鈕超過2秒，送風葉會自動左右擺動。

擺動按鈕(⬇️)：

此功能不適用於此款型號機型。

⑬涼風追蹤按鈕(FOLLOW ME)：按此按鈕啟動涼風追蹤功能，遠程顯示其位置的實際溫度。遙控器將每3分鐘間隔發送一次信號到冷氣機，直到再次按下“涼風追蹤 FOLLOW ME”按鈕。如果7分鐘間隔內沒有收到信號，冷氣機將自動取消“涼風追蹤”功能。

⑭LED 按鈕：關閉/開啟冷氣機屏幕顯示。當按下按鈕時，冷氣機屏幕顯示會關閉，再次按下可以開啟顯示。

的指示

信

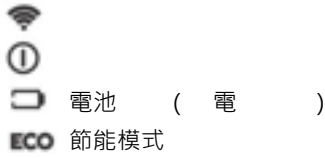
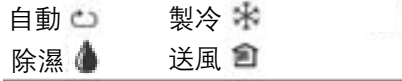

屏

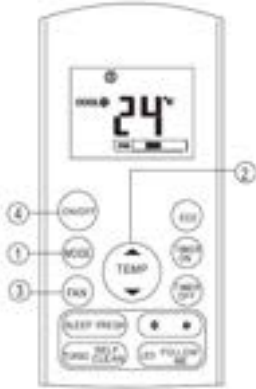

1. 製冷 (COOL) 或送風 (FAN)
2. °C 30°C °C
3. 減
4. 定
模 3

抽濕運行操作方法

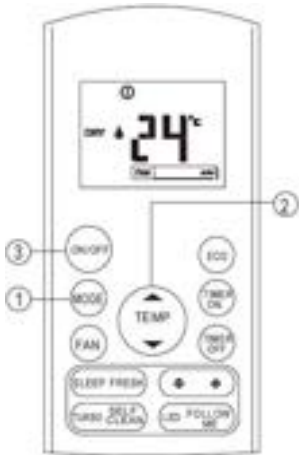

1. 抽濕 ()
2. °C 30°C °C
3. 減
在抽濕模式 定

自動模式操作方法

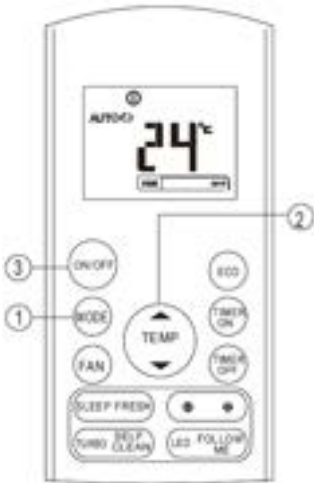

1. 按 MODE 按鈕選擇自動 (AUTO)。
2. 按 UP / DOWN 按鈕設置所需的溫度。溫度可以設置在 17°C ~ 30°C 的範圍內，以 1°C 為增減。
3. 按 ON / OFF 按鈕啟動冷氣機。

注意：

1. 在自動模式下，冷氣機可以通過檢測實際環境溫度與遙控器上的設定溫度之間的差異來邏輯選擇製冷和送風模式。
2. 在自動模式下，風速設定為自動控制。
3. 若 AUTO 模式運行使您感到不適，可手動選擇其他運行模式。



定時操作

定時開機的設定

1. 按下定時開機 (TIMER ON) 按鈕。遙控器顯示 TIMER ON，上次自動開機設定時間和信號“H”將顯示在 LCD 顯示屏。現在，您可以重新啟動自動啟動操作。
2. 再次按下 TIMER ON 按鈕設置所需的自動啟動時間。每次按下按鈕，時間在 0 到 10 小時之間增加半小時，在 10 到 24 小時之間增加 1 小時。
3. 在設置 TIMER ON 開啟之後，遙控器將延遲一秒鐘傳送信號到冷氣機。然後，經過大約 2 秒鐘後，信號“H”將消失，設定溫度將重新出現在 LCD 顯示屏上。通過將其計時器設置為 0.0H 來取消此功能。

定時關機的設定

1. 按 TIMER OFF 按鈕。遙控器顯示 TIMER OFF，上次自動關機設定時間和信號“H”將顯示在 LCD 顯示屏。現在，您可以重新設置自動關機時間來停止操作。
2. 再次按下 TIMER OFF 按鈕設置所需的自動關機時間。每次按下按鈕，時間在 0 到 10 小時之間增加半小時，在 10 到 24 小時之間增加 1 小時。
3. 在設置 TIMER 關閉後，遙控器將延遲一秒鐘傳送信號到冷氣機。然後，經過大約 2 秒鐘後，信號“H”將消失，設定溫度將重新出現在 LCD 顯示屏上。通過將其計時器設置為 0.0h 來取消此功能。

注意

- 由遙控器為定時器功能設置的有效操作時間限制為以下設置：0.5, 1.0, 1.5, 2.0, 2.5, 3.0, 3.5, 4.0, 4.5, 5.0, 5.5, 6.0, 6.5, 7.0, 7.5, 8.0, 8.5, 9.0, 9.5, 10, 11, 12, 13, 14, 15, 16, 17, 18, 19, 20, 21, 22, 23 及 24。

機

用

定



1. 信號 屏

6

2. ON 顯示屏上顯示“6.0H”。

3. 3 屏

定時關機 (自動關機操作)

當您想要在睡覺後自動關閉本機時，TIMER OFF 功能非常有用。冷氣機將在設定時間內自動停機。

例如：在 10 小時內停機。



設置 10 小時後

1. 按 TIMER OFF 按鈕，停止運行時間的最後一個設置和信號“H”將顯示在顯示屏。

2. 按下 TIMER OFF 按鈕，在遙控器的 TIMER OFF 顯示屏上顯示“10H”。

3. 等待 3 秒鐘，數碼顯示屏再次顯示溫度。
“TIMER OFF” 指示燈保持開啟及此功能被開啟。



組合定時器 (同時設置 ON 和 OFF 定時器)

定時關機→定時開機。

當您想在睡覺後關閉空調，並在早上醒來或回家時再次啟動時，此功能很有用。

例如：

設置後 2 小時停止冷氣機，設置後 10 小時再次啟動。

1. 按 TIMER OFF 按鈕。
2. 再次按下 TIMER OFF 按鈕，在 TIMER OFF 顯示屏上顯示 2.0H。
3. 按下 TIMER ON 按鈕。
4. 再次按下 TIMER ON 按鈕，在 TIMER ON 顯示屏上顯示 10H。
5. 等待 3 秒鐘，數碼顯示屏再次顯示溫度。
“TIMER ON 和 TIME OFF” 指示燈保持開啟
及此功能被開啟。

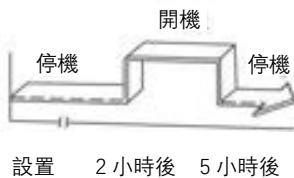

定時開機→定時關機

當您想在起床前啟動冷氣機並在離開家後停止冷氣機時，此功能非常有用。

例如：

設置後 2 小時啟動冷氣機，設置後 5 小時停止。

1. 按下 TIMER ON 按鈕。
2. 再次按下 TIMER ON 按鈕，在 TIMER ON 顯示屏上顯示 2.0H。
3. 按下 TIMER OFF 按鈕。
4. 再次按下 TIMER OFF 按鈕，在 TIMER OFF 設置顯示屏上顯示 5.0H。
5. 等待 3 秒鐘，數碼顯示屏再次顯示溫度。
“TIMER ON 和 TIMER OFF” 指示燈保持開啟
及此功能被開啟。



使用距離 8





- 到 信號 用
-
- 信號 使
- 用 電
-
-



電池電 用 電池

電池
信號 到

-
-

兩 乾電池 (AAA)

電

電池 電池 ()

(-)

電池

電池



- 電池 電池
- 用 3 使用
- 電池
- 不要將電池作為未分類的垃圾處理。有關正確處理電池，請參閱當地法律。

● 特別聲明

1. 以上資料已經過核對；如有任何印刷錯誤或內容方面的誤解，本公司將保留解釋權。
2. 本產品若有技術方面的改進，新版的操作說明中將會加入有關資料，恕不另行通知。產品外觀及顏色以冷氣機實物為準。
3. 本公司可應要求通過電子郵件發送電子版的用戶指南，請致電信興電工工程有限公司熱線電話2861 2767。

● 售後服務

保修期為購買日起計一年。如產品損毀屬正常使用下發生者，本公司可提供免費維修服務。請出示正式收據及蓋有銷售點/換購中心印章的保修證，以享用免費維修服務。如有查詢，請致電信興電器服務中心有限公司熱線電話2406 5666。

如發生以下任何情況，請立即關閉電源並聯絡信興電器服務中心有限公司。

- 斷路器經常跳掣或保險絲常被燒斷。
- 水或異物意外進入冷氣機內。
- 冷氣機操作時發出異常聲音。

信興電工工程有限公司

SHUN HING ELECTRIC WORKS & ENGINEERING CO., LTD

辦公室: 香港九龍尖沙咀東部麼地道 67 號半島中心 9 樓

OFFICE: 9/F, PENINSULA CENTRE, 67 MODY ROAD, TSIMSHATSUI EAST,
KOWLOON, HONG KONG

電話 TEL: (852) 2861 2767

傳真 FAX: (852) 2865 6706

網址 WEBSITE: www.shew.com.hk

電郵 EMAIL: shew@shunhinggroup.com

保養及維修 MAINTENANCE AND REPAIR SERVICE

信興電器服務中心有限公司

SHUN HING ELECTRIC SERVICE CENTRE LTD.

辦公室: 香港新界葵涌勝耀街2號信興中心11樓

OFFICE: 11TH FLOOR, SHUN HING CENTRE, 2 SHING YIU STREET, KWAI CHUNG, NEW
TERRITORIES, HONG KONG

電話 TEL: (852) 2406 5666

傳真 FAX: (852) 2408 0316

網址 WEBSITE: www.shesc.com

消耗品/附件銷售熱線 CONSUMABLES/ ACCESSORIES SALES HOTLINE

電話 TEL: (852) 2406 5666

客戶服務中心 CUSTOMER SERVICE CENTRES

香港新界葵涌勝耀街2號信興中心1樓

1ST FLOOR, SHUN HING CENTRE, 2 SHING YIU STREET, KWAI CHUNG, NEW
TERRITORIES, HONG KONG

電話 TEL: (852) 2406 5439

傳真 FAX: (852) 2408 1389

澳門慕拉士大馬路193-199號南嶺工業大廈5樓I座

AVENIDA DE VENCESLAU DE MORAIS, NO. 193-199, 5 ANDAR-I, EDF. INDUSTRIAL
NAM LENG, MACAU

電話 TEL: (853) 2836 2928

傳真 FAX: (853) 2833 6405

有關最新之客戶服務中心資訊, 請參閱信興服務中心網址: www.shesc.com或致電維修服務熱線查詢。

For the latest information of customer service centres, please visit www.shesc.com or call us at our hotline.



R32 INVERTER COOLING
WINDOW-TYPE AIR CONDITIONER

Remote Controller Operation Manual

Model:

RC-TS7UV

RC-TS9UV

RC-TS12UV

RC-TS18UV

RC-TS24UV

IMPORTANT NOTE:

Thank you for purchasing our air conditioner. Please read this manual carefully before operating your new air conditioning unit. Make sure to save this manual for future reference.

CONTENTS

Specifications	2
Feature of the remote control buttons	3
Display panel indicators	6
Operation instruction	7
Handling the remote control	12

NOTE:

- Buttons design is based on typical model and might be slightly different from the actual one you purchased, the actual shape shall prevail.
- All the functions described are accomplished by the unit. If the unit does not have certain feature, there will be no corresponding operation happened when pressing the relative button on the remote control.

Specifications

Rated Voltage	3.0V(Dry batteries AAA×2)
Signal Receiving Range	8m
Environment	-5°C ~60°C



Feature of the remote control buttons

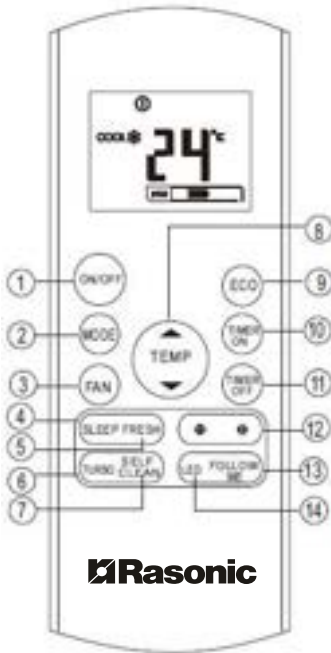

① **ON/OFF Button:** This button turns the air conditioner ON and OFF.

② **MODE Button:** Press this button to modify the air conditioner mode in a sequence of following:



③ **FAN Button:** To select the fan speed in four steps:



NOTE: You cannot switch the fan speed in DRY mode

④ **SLEEP Button:** Activate/Deactivate sleep function.

NOTE: This mode is only available in COOL mode. While the unit is running under SLEEP mode, it would be cancelled if MODE, FAN SPEED or ON/OFF button is pressed.

⑤ **FRESH Button:** Press this button to activate UV which helps to kill bacteria and viruses in the air.

⑥ **TURBO Button:** Activate/Deactivate Turbo function. Turbo function enables the unit to reach the preset temperature at cooling operation in the shortest time.

- ⑦ **SELF CLEAN Button:**(Applicable for RC-TS7UV, RC-TS9UV and RC-TS12UV only)
Airborne bacteria can grow in the moisture that condenses around heat exchanger in the unit.
With regular use, most of this moisture is evaporated from the unit. By pressing the SELF CLEAN button, your unit will clean itself automatically. After cleaning, the unit will turn off automatically.
Pressing the SELF CLEAN button mid-cycle will cancel the operation and **turn off the unit.**
You can use SELF CLEAN as often as you like.
Note: You can only activate this function in COOL or DRY mode.
- ⑧ **TEMP UP Button (TEMP ▲) :** Press this button to increase the indoor temperature setting in 1°C increments to 30°C.
TEMP DOWN Button (TEMP ▼) : Press this button to decrease the indoor temperature setting in 1°C decrements to 17°C.
Note: Temperature cannot be adjusted in FAN mode.
- ⑨ **ECO Button :** Used to enter the energy efficient mode. Under cooling mode, press this button, the remote control will adjust the temperature automatically to 24°C. Auto fan speed to save energy(but only if the set temperature is less than 24°C). If the set temperature is between 24°C and 30°C, press the ECO button. the fan speed will change to Auto, the set temperature will remain unchanged. NOTE:
1. Pressing the TURBO and SLEEP button, changing the mode or adjusting the set temperature to less than 24°C will stop ECO operation.
 2. Under ECO operation, the set temperature should be 24°C or more, but it may result in insufficient cooling. If you feel uncomfortable, just press the ECO button again to stop it.
- ⑩ **TIMER ON Button :** Press this button to initiate the auto-on time sequence. Each press will increase the auto-timed setting in 30 minutes increments. When the setting time displays "10.0", each press will increase the auto-timed setting 60 minutes increments.
To cancel the auto-timed program, simply adjust the auto-on time to "0.0".
- ⑪ **TIMER OFF Button :** Press this button to initiate the auto-off time sequence. Each press will increase the auto-timed setting in 30 minutes increments.

When the setting time displays 10.0, each press will increase the auto-timed setting 1 hour increments. To cancel the auto-timed program, simply adjust the auto-off time to 0.0.

- ⑫ **Swing (◀▶) Button** : Used to stop or start vertical louver movement and set the desired left/right air flow direction. The vertical louver changes 6 degree in angle for each press. If hold down this button for more than 2 seconds, the louver will swing left and right automatically.

Swing (◆) Button :

This function is not applicable for this model.

- ⑬ **Follow Me Button** : Push this button to initiate the Follow Me feature, the remote display is actual temperature at its location. The remote control will send this signal to the air conditioner every 3 minutes interval until press the Follow Me button again. The air conditioner will cancel the Follow Me feature automatically if it does not receive the signal during any 7 minutes interval.

- ⑭ **LED Button** : Activate/Deactivate unit screen Display. When pressing the button, the unit screen display will be deactivated, press it again to activate the display.

Display panel indicators

Information are displayed when the remote control is powered up.



Mode display



- Displayed when data transmitted.
- Displayed when remote control is ON.
- Battery display (low battery detection).
- ECO** Energy efficient mode.

- ON Displayed when TIMER ON time is set.
- OFF Displayed when TIMER OFF time is set.
- Show set temperature or room temperature, or time under TIMER setting.

- Displayed in Sleep Mode operation.
- Indicated that the air condition is operating in Follow me mode

Fan speed indication

- | | |
|--|--------------|
| | Low speed |
| | Medium speed |
| | High speed |
| | Auto speed |

Note:

All indicators shown in the figure are for the purpose of clear presentation. But during the actual operation only the relative functional signs will be shown on the display.

Operation instruction

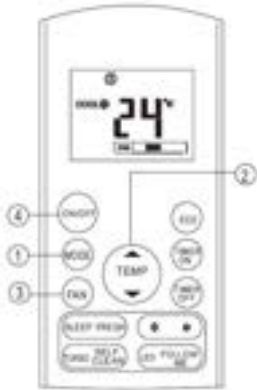

Cooling / Fan mode operation

Ensure the unit is plugged in and power is available.

1. Press the MODE button to select COOL or FAN mode.
2. Press the UP/DOWN buttons to set the desired temperature. The temperature can be set within a range of 17°C ~ 30°C in 1°C increments or decrements.
3. Press the FAN button to select the fan speed in four steps- Auto, Low, Med, or High.
4. Press the ON/OFF button to start the air conditioner.

NOTE

Temperature cannot be adjusted in FAN mode, thus only process step 1, 3 and 4 when running in FAN mode.

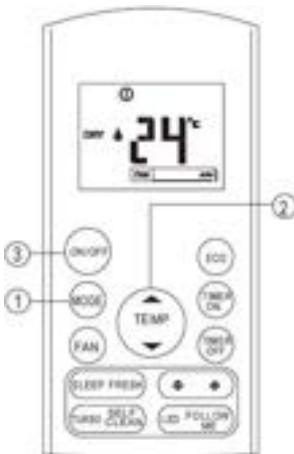

DRY operation

1. Press the MODE button to select DRY mode.
2. Press the UP/DOWN buttons to set the desired temperature. The temperature can be set within a range of 17°C ~ 30°C in 1°C increments or decrements.
3. Press the ON/OFF button to start the air conditioner.

NOTE:

In the DRY mode, the fan speed will be automatically set.

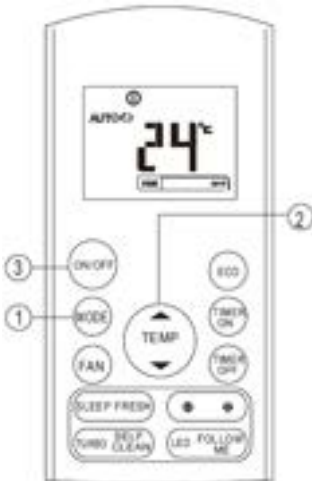

Auto operation

1. Press the MODE button to select Auto.
2. Press the UP/DOWN button to set the desired temperature. The temperature can be set within a range of 17°C ~ 30°C in 1°C increments or decrements.
3. Press the ON/OFF button to start the air conditioner.

NOTE

1. In the Auto mode, the air conditioner can logically choose the mode of Cooling and Fan, by sensing the difference between the actual ambient room temperature and the setting temperature on the remote control.
2. In the Auto mode, the fan speed will be automatically set.
3. If the Auto mode is not comfortable for you, the desired mode can be selected manually.

Timer operation



TIMER ON Setting

1. Press the TIMER ON button. The remote control shows TIMER ON, the last Auto-on setting time and the signal "H" will be shown on the LCD display. Now it is ready to reset the Auto-on time to START the operation.
2. Press the TIMER ON button again to set desired Autoon time. Each time you press the button, the time increases by half an hour between 0 and 10 hours and by one hour between 10 and 24 hours.
3. After setting the TIMER ON, there will be a one second delay before the remote control transmits timing the signal to the air conditioner. Then, after approximately another 2 seconds, the signal "H" will disappear and the set temperature will re-appear on the LCD display. Cancel function by setting timer to 0.0H.

TIMER OFF Setting

1. Press the TIMER OFF button. The remote control will show TIMER OFF, the last Auto-off setting time and the signal "H" will be shown on the LCD display . Now it is ready to reset the Auto-off time to stop the operation.
2. Press the TIMER OFF button again to set the desired Auto-off time. Each time you press the button, the time increases by half an hour between 0 and 10 hours and by one hour between 10 and 24 hours.
3. After setting the TIMER OFF, there will be a one second delay before the remote control transmits the signal to the air conditioner. Then, after approximately another 2 seconds, the signal "H" will disappear and the set temperature will re-appear on the LCD display. Cancel function by setting timer to 0.0H.

▲ CAUTION

- The effective operation time set by the remote control for the timer function is limited to the following settings: 0.5, 1.0, 1.5, 2.0, 2.5, 3.0, 3.5, 4.0, 4.5, 5.0, 5.5, 6.0, 6.5, 7.0, 7.5, 8.0, 8.5, 9.0, 9.5, 10, 11, 12, 13, 14, 15, 16, 17, 18, 19, 20, 21, 22, 23 and 24.

Example of timer setting

TIMER ON (Auto-on Operation)

The TIMER ON feature is useful when you want the unit to turn on automatically before you return home. The air conditioner will automatically start operating at the set time.

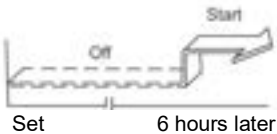

Example

To start the air conditioner in 6 hours.

1. Press the TIMER ON button, the last setting of starting operation time and the signal "H" will show on the display.
2. Press the TIMER ON button to display "6.0H" on the TIMER ON display of the remote control.
3. Wait for 3 seconds and the digital display will show the temperature again. The "TIMER ON" indicator will remain on and this function will be activated.

TIMER OFF (Auto-off Operation)

The TIMER OFF feature is useful when you want the unit to turn off automatically after you go to bed. The air conditioner will stop automatically at the set time.

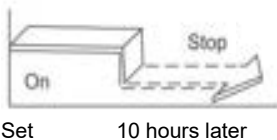

Example

To stop the air conditioner in 10 hours.

1. Press the TIMER OFF button, the last setting of stopping operation time and the signal "H" will show on the display.
2. Press the TIMER OFF button to display "10H" on the TIMER OFF display of the remote control.
3. Wait for 3 seconds and the digital display will show the temperature again. The "TIMER OFF" indicator will remain on and this function will be activated.

COMBINED TIMER

TIMER OFF → TIMER ON

This feature is useful when you want to stop the air conditioner after you go to bed, and start it again in the morning when you wake up or when you return home.



Example

To stop the air conditioner 2 hours after setting and start it again 10 hours after setting.

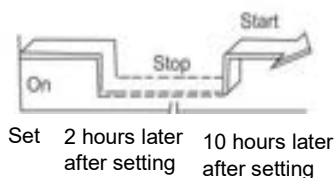

1. Press the TIMER OFF button.
2. Press the TIMER OFF button again to display 2.0H on the TIMER OFF display.
3. Press the TIMER ON button.
4. Press the TIMER ON button again to display 10H on the TIMER ON display.
5. Wait for 3 seconds and the digital display will show the temperature again. The "TIMER ON & TIME OFF" indicator will remain on and this function will be activated.

TIMER ON → TIMER OFF

This feature is useful when you want to start the air conditioner before you wake up and stop it after you leave the house.

Example

To start the air conditioner 2 hours after setting, and stop it 5 hours after setting.

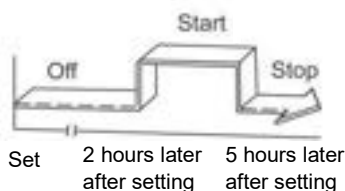

1. Press the TIMER ON button.
2. Press the TIMER ON button again to display 2.0H on the TIMER ON display.
3. Press the TIMER OFF button.
4. Press the TIMER OFF button again to display 5.0H on the TIMER OFF display.
5. Wait for 3 seconds and the digital display will show the temperature again. The "TIMER ON & TIMER OFF" indicator will remain on and this function will be activated.

Handling the remote control



Range of use of the remote control.

Use the remote control within a distance of 8 meters from the appliance, and point it at the receiver. Reception is confirmed by a "beep".

CAUTION

- The air conditioner will not operate if curtains, doors or other materials block the signals from the remote control to the unit.
- Prevent any liquid from falling into the remote control. Do not expose the remote control to direct sunlight or heat.
- If the infrared signal receiver on the unit is exposed to direct sunlight, the air conditioner may not function properly. Use curtains to prevent the sunlight from falling on the receiver.
- If other electrical appliances react to the remote control, either move these appliances or consult your local dealer.
- Do not drop the remote control. Handle with care.
- Do not place heavy objects on the remote control.

Batteries replacement



The following conditions indicate that the battery power is exhausted, replace the old battery with a new one.

- No received beeps when sending a signal.
- The indicator light disappears.

The remote control is powered by two dry batteries (AAAX2) which were inserted in the rear compartment and protected by a cover.

- (1) Remove the cover on the rear of the remote control.
- (2) Take out the old batteries and insert the new one, with the (+) and (-) ends positioned correctly.
- (3) Reinstall the cover.

NOTE: When the batteries are removed, the remote control will clear all settings. After inserting new batteries, the remote control must be reset.

CAUTIONS

- Do not mix old and new batteries or batteries of different types.
- If you do not use the remote for 2 or 3 months or more controller, please remove the battery.
- Do not dispose of batteries as unsorted municipal waste. Refer to local laws for proper disposal of batteries.

● Special Avowal

- 1. The information above has been checked; our company reserves the hermeneutic power to any print errors or misunderstanding on the content.**
- 2. Any technology improvement will add into new instruction without any prior notices. The product appearance and color refer to the practical air conditioner.**
- 3. The e-copy of user manual can be sent by e-mail on requested, please call Shun Hing Electric Works & Engineering Co. Ltd. hotline at 2861 2767.**

● After sale service

Guarantee period state from the date of purchasing to one year. If the product is damaged under proper use, a free repair service is available. Please present the official invoice and the guarantee certificate with the sales point's chop / redemption center's chop for free maintenance. For enquiries, please contact Shun Hing Electric Service Centre Limited hotline at 2406 5666.

Turn off the power and contact Shun Hing Electric Service Centre Ltd. as soon as any of the following events occur.

- The circuit breaker frequently trips or the fuse blows regularly.
- If water or foreign objects have accidentally entered the air conditioner.
- If there is abnormal sound during operation.

信興電工工程有限公司

SHUN HING ELECTRIC WORKS & ENGINEERING CO., LTD

辦公室: 香港九龍尖沙咀東部麼地道 67 號半島中心 9 樓

OFFICE: 9/F, PENINSULA CENTRE, 67 MODY ROAD, TSIMSHATSUI EAST,
KOWLOON, HONG KONG

電話 TEL: (852) 2861 2767

傳真 FAX: (852) 2865 6706

網址 WEBSITE: www.shew.com.hk

電郵 EMAIL: shew@shunhinggroup.com

保養及維修 MAINTENANCE AND REPAIR SERVICE

信興電器服務中心有限公司

SHUN HING ELECTRIC SERVICE CENTRE LTD.

辦公室: 香港新界葵涌勝耀街2號信興中心11樓

OFFICE: 11TH FLOOR, SHUN HING CENTRE, 2 SHING YIU STREET, KWAI CHUNG, NEW
TERRITORIES, HONG KONG

電話 TEL: (852) 2406 5666

傳真 FAX: (852) 2408 0316

網址 WEBSITE: www.shesc.com

消耗品/附件銷售熱線 CONSUMABLES/ ACCESSORIES SALES HOTLINE

電話 TEL: (852) 2406 5666

客戶服務中心 CUSTOMER SERVICE CENTRES

香港新界葵涌勝耀街2號信興中心1樓

1ST FLOOR, SHUN HING CENTRE, 2 SHING YIU STREET, KWAI CHUNG, NEW
TERRITORIES, HONG KONG

電話 TEL: (852) 2406 5439

傳真 FAX: (852) 2408 1389

澳門慕拉士大馬路193-199號南嶺工業大廈5樓1座

AVENIDA DE VENCESLAU DE MORAIS, NO. 193-199, 5 ANDAR-I, EDF. INDUSTRIAL
NAM LENG, MACAU

電話 TEL: (853) 2836 2928

傳真 FAX: (853) 2833 6405

有關最新之客戶服務中心資訊, 請參閱信興服務中心網址: www.shesc.com或致電維修服務熱線查詢。

For the latest information of customer service centres, please visit www.shesc.com or call us at our hotline.



“信興集團” 手機應用程式使用及操作說明

(適用於樂信牌冷氣機)

注意

1. 適用系統: iOS / Android
 - 請保持APP為最新版本。
 - 由於特殊情況有機會發生，我們明確聲明如下：
並非所有iOS和Android系統都與手機應用程式兼用，對於因不兼容而產生的任何問題，我們概不負責。
2. 手機應用程式可能會為了產品功能的改進而隨時更新，恕不另行通知。
3. 手機應用程式不能在完全斷電的情況下運作，用戶必須保持冷氣機在接電狀態 (待機模式)下功能才可正常運作。

適用型號:

窗口機: RC-TS7UV, RC-TS9UV, RC-TS12UV, RC-TS18UV, RC-TS24UV





“信興集團” 手機應用程式使用及操作說明

(適用於樂信牌冷氣機)

×

選擇 2.4GHz Wi-Fi 網絡並輸入密碼

如果你的 Wi-Fi 是 5GHz 的，請先設置為 2.4GHz [常見路由器的設置方法](#)



1. 請於路由器設置2.4GHz Wi-Fi 網絡，並開啟手機的藍牙功能。
2. 掃描以上二維碼下載”信興集團“手機應用程式，並且進行註冊及登入。



“信興集團” 手機應用程式使用及操作說明

(適用於樂信牌冷氣機)



3. 在完成註冊及登入後，進入應用程式主界面，點選【添加設備】。



“信興集團” 手機應用程式使用及操作說明

(適用於樂信牌冷氣機)

正在蒐集附近的設備，請確保設備處於開機狀態

手動添加

所有產品

辦公室

冷氣機

電風扇



HC-15系列



HC-15系列



圖標 >

名稱 >

位置 >

窗口機 >

4. 連接方式:
按住機上控制面板“SWING”按鈕3秒，控制面上顯示屏會出現“AP”，然後連接產品。



“信興集團” 手機應用程式使用及操作說明

(適用於樂信牌冷氣機)



5. 程式自動搜尋附近的設備，按步驟啟動相機功能，再掃描右方二維碼，選擇2.4GHz Wi-Fi 網絡後便能成功連接設備。





“信興集團” 手機應用程式使用及操作說明

(適用於樂信牌冷氣機)

<



圖標

>

名稱

窗口機 >

位置

>

6. 裝置添加後，用戶可自定裝置名稱並指定裝置所在房間。

註: 因窗口機與分體機共用相同手機應用程式，如單位內超過1部相同系列的冷氣機，建議更改不同名稱及位置以便識別。



“信興集團” 手機應用程式使用及操作說明

(適用於樂信牌冷氣機)



7. 連接成功後，點擊左下角【開/關】鍵可啟動或關閉冷氣機。



“信興集團” 手機應用程式使用及操作說明

(適用於樂信牌冷氣機)



8. 點擊【模式】鍵可選擇 自動、製冷、抽濕及送風 模式。
關於各個模式的說明請參閱使用及安裝說明書。



“信興集團” 手機應用程式使用及操作說明

(適用於樂信牌冷氣機)



9. 點擊【風速】鍵可選擇 自動、低風速、中風速及高風速。
關於各個風速的說明請參閱使用及安裝說明書。



“信興集團” 手機應用程式使用及操作說明

(適用於樂信牌冷氣機)



10. 點擊【 - 】或【 + 】鍵可調節或設定所需溫度。
(於【抽濕】及【送風】模式下溫度不能設定)



“信興集團” 手機應用程式使用及操作說明

(適用於樂信牌冷氣機)



11. 其他功能:

- ① 【強力】鍵 – 快速降低室內溫度。
 - ② 【ECO】鍵 – 進入節能模式。
 - ③ 【左右搖擺】鍵 – 啟動或停止送風葉擺動。
 - ④ 【自動清潔】鍵 – 啟動或關閉冷氣機自動清潔功能。
- 以上功能詳情請參閱使用及安裝說明書。



“信興集團” 手機應用程式使用及操作說明

(適用於樂信牌冷氣機)



12. 點擊右下角【定時】鍵可設定啟動或關閉冷氣機時間。



“信興集團” 手機應用程式使用及操作說明

(適用於樂信牌冷氣機)



13. 點擊【定時】鍵後，請按以下步驟設定：
- ① 設定小時(左)及分鐘(右)。



“信興集團” 手機應用程式使用及操作說明

(適用於樂信牌冷氣機)



- ② 點擊【重複】鍵，可設定每個星期指定時間重複或只執行一次啟動或關閉冷氣機時間，選擇後點擊【儲存】鍵儲存設定。



“信興集團” 手機應用程式使用及操作說明

(適用於樂信牌冷氣機)



- ③ 點擊【開關】鍵，選擇定時啟動或定時關閉冷氣機，確定後按【儲存】鍵儲存設定。



“信興集團” 手機應用程式使用及操作說明

(適用於樂信牌冷氣機)



- ④ 點擊【模式】鍵，選擇定時啟動時的模式，確定後點擊【儲存】鍵儲存設定。



“信興集團” 手機應用程式使用及操作說明

(適用於樂信牌冷氣機)



- ⑤ 點擊【溫度】鍵，選擇定時啟動時的設定溫度，確定後點擊【儲存】鍵儲存設定。



“信興集團” 手機應用程式使用及操作說明

(適用於樂信牌冷氣機)



- ⑥ 點擊【風速】鍵，選擇定時啟動時的設定風速，確定後點擊【儲存】鍵儲存設定。



“信興集團” 手機應用程式使用及操作說明

(適用於樂信牌冷氣機)

< 新增定時 儲存

0 00

1 01

重複 僅一次 >

備註 >

開關 關閉 >

模式 製冷 >

溫度 24°C >

風速 自動 >

- ⑦ 設定完成後，點擊【儲存】鍵儲定時啟動或定時關閉設定。



“信興集團” 手機應用程式使用及操作說明

(適用於樂信牌冷氣機)



14. 創建場景:

點擊下方正中位置【場景】進入【創見場景】設置頁面，可設定在指定環境(如定時、氣象變化等)下執行指令。

註：

- 氣象變化資訊及數據由第三方提供。
- 執行指令一般會有 10-15 分鐘延時。



“信興集團” 手機應用程式使用及操作說明

(適用於樂信牌冷氣機)



15. 共享裝置:

點擊右上角【...】進入設置頁面，點擊【共享裝置】，點擊【信興集團帳號】，輸入被分享用戶的電郵地址便可，新增帳號後可多人控制設備。

註：

- 必須是這個設備的主用戶才能使用分享功能，被分享的用戶必須註冊並登入信興集團手機應用程式，否則無法使用分享功能；
- 共享裝置上限人數為20人。



“信興集團” 手機應用程式使用及操作說明

(適用於樂信牌冷氣機)



16. 移除設備:

點擊右上角【...】進入設置頁面，
點擊【移除裝置】，可移除設備。
確認移除後，設備需重新啟動及
重新連接信興集團手機應用程式。



“信興集團” 手機應用程式使用及操作說明

(適用於樂信牌冷氣機)

Rasonic 樂信牌

信興電工工程有限公司

SHUN HING ELECTRIC WORKS & ENGINEERING CO., LTD

辦公室: 香港九龍尖沙咀東部麼地道67號半島中心9樓

OFFICE: 9/F, PENINSULA CENTRE, 67 MODY ROAD,

TSIMSHATSUI EAST, KOWLOON, HONG KONG

電話 TEL: (852) 2861 2767 傳真 FAX: (852) 2865 6706

網址 WEBSITE: www.shew.com.hk

電郵 EMAIL: shew@shunhinggroup.com

保養及維修 **MAINTENANCE AND REPAIR SERVICE**

信興電器服務中心有限公司

SHUN HING ELECTRIC SERVICE CENTRE LTD.

辦公室: 香港新界葵涌勝耀街2號信興中心11樓

OFFICE: 11TH FLOOR, SHUN HING CENTRE, 2 SHING YIU STREET, KWAI CHUNG, NEW

TERRITORIES, HONG KONG

電話 TEL: (852) 2406 5666

傳真 FAX: (852) 2408 0316

網址 WEBSITE: www.shesc.com

消耗品/附件銷售熱線 CONSUMABLES/ ACCESSORIES SALES HOTLINE

電話 TEL: (852) 2406 5666

客戶服務中心 **CUSTOMER SERVICE CENTRES**

香港新界葵涌勝耀街2號信興中心1樓

1ST FLOOR, SHUN HING CENTRE, 2 SHING YIU STREET, KWAI CHUNG, NEW TERRITORIES, HONG KONG

電話 TEL: (852) 2406 5439

傳真 FAX: (852) 2408 1389

澳門慕拉士大馬路149號激成工業大廈(第一期)2樓F座

Avenida de Venceslau de Morais, No. 149, 2 andar - F, Edf, Industrial Keck Seng (Bloco 1), Macau

電話 TEL: (853) 2836 2928

傳真 FAX: (853) 2833 6405

有關最新之客戶服務中心資訊, 請參閱信興服務中心網址 www.shesc.com 或致電維修服務熱線查詢。

For the latest information of customer service centres, please visit www.shesc.com or call us at our hotline.



"Shun Hing Group" Mobile App Operation Manual

(Applicable for Rasonic Air Conditioner)

CAUTION

1. Compatible Systems: iOS / Android
 - Please keep the app up to date.
 - Due to unforeseen circumstances, we hereby explicitly state the following:
Not all iOS and Android systems are compatible with the mobile app. We are not responsible for any issues arising from incompatibility.
2. The mobile app may be updated at any time to improve product functionality without prior notice.
3. The mobile app cannot operate when completely powered off.
Users must keep the air conditioner plugged in (standby mode) for it to function properly.

Applicable models:

Window Air Conditioner:

RC-TS7UV, RC-TS9UV, RC-TS12UV, RC-TS18UV, RC-TS24UV



Rasonic 樂信牌



"Shun Hing Group" Mobile App Operation Manual

(Applicable for Rasonic Air Conditioner)



Select 2.4 GHz Wi-Fi Network and enter password.

If your Wi-Fi is 5GHz, please set it to be 2.4GHz.
[Common router setting method](#)



1. Please configure your router to use a 2.4GHz Wi-Fi network and enable Bluetooth on your phone.

2. Scan the QR code to download the "Shun Hing Group" mobile app and then register and log in.



"Shun Hing Group" Mobile App Operation Manual

(Applicable for Rasonic Air Conditioner)

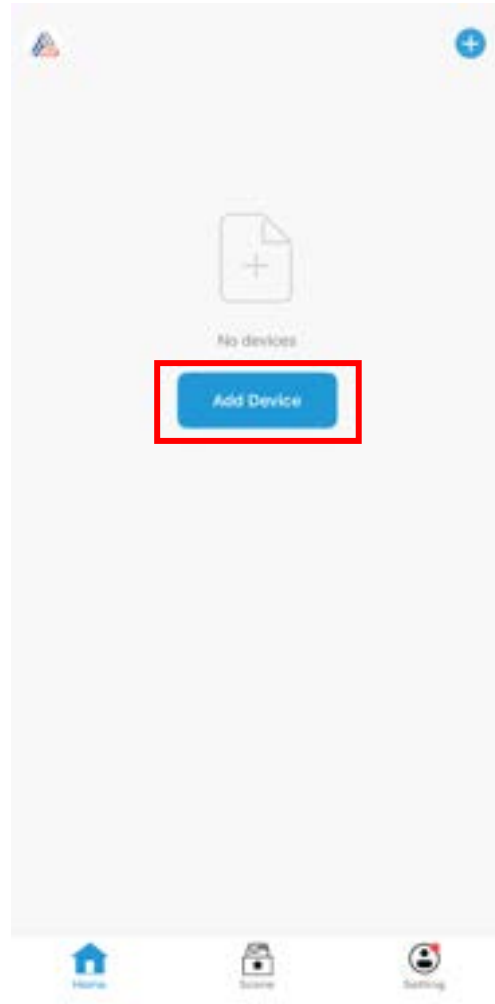

3. After completing registration and login, you will enter the app's main interface. Click [Add Device].



"Shun Hing Group" Mobile App Operation Manual

(Applicable for Rasonic Air Conditioner)

< Add Device >

Searching for nearby devices. Make sure your device has entered pairing mode.

Add Manually

Hot Products

Smart Lock

Air Conditioner

Electric Fan



KS-TS Series

KC-TS Series



<



Icon >

Name >

Window air conditio... >

Location >

4. Connection Method:

Press and hold the "SWING" button on the control panel for 3 seconds, "AP" will show on the display panel. Then connect the product.



"Shun Hing Group" Mobile App Operation Manual

(Applicable for Rasonic Air Conditioner)



5. The app automatically searches for nearby devices. Follow the steps to activate the camera function, scan the QR code on the right, select the 2.4GHz Wi-Fi network, and you can successfully connect to the device.





"Shun Hing Group" Mobile App Operation Manual

(Applicable for Rasonic Air Conditioner)



6. After adding the unit, users can customize the unit name and specify the room where the unit is located.
Note: Because window and split-type air conditioner share the same mobile app, if there are more than one air conditioner of the same series in the unit, it is recommended to change the name and location of the unit for easy identification.



"Shun Hing Group" Mobile App Operation Manual

(Applicable for Rasonic Air Conditioner)



7. After successful connection, click the [On/Off] button in the lower left corner to turn the air conditioner on or off.



"Shun Hing Group" Mobile App Operation Manual

(Applicable for Rasonic Air Conditioner)

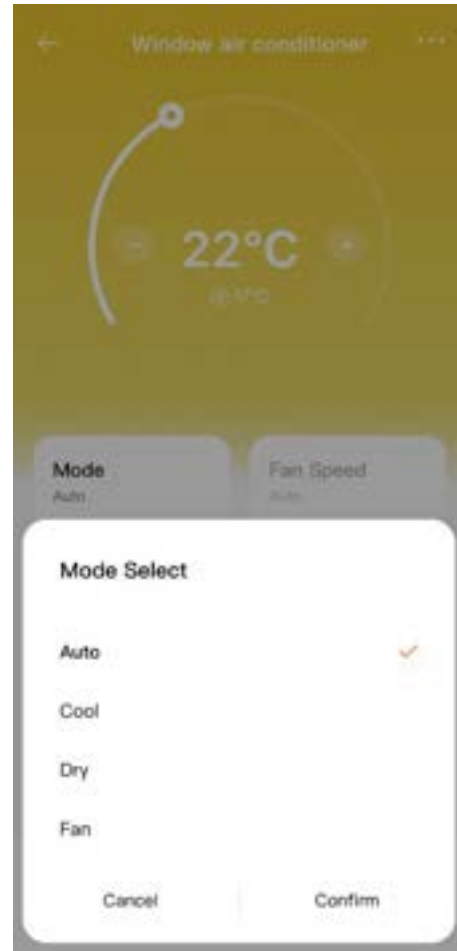
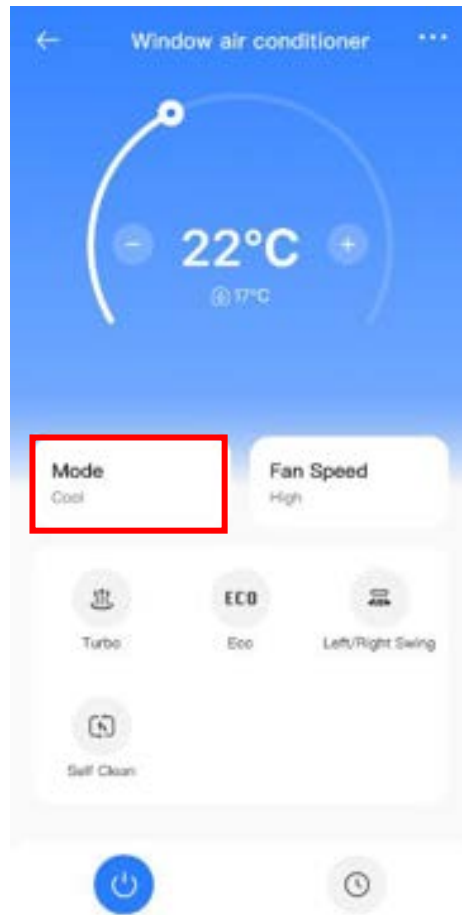

8. Click the [Mode] button to select Auto, Cooling, Dry and Fan Mode.
Please refer to the operation and installation manual and installation instructions for explanations of each mode.



"Shun Hing Group" Mobile App Operation Manual

(Applicable for Rasonic Air Conditioner)

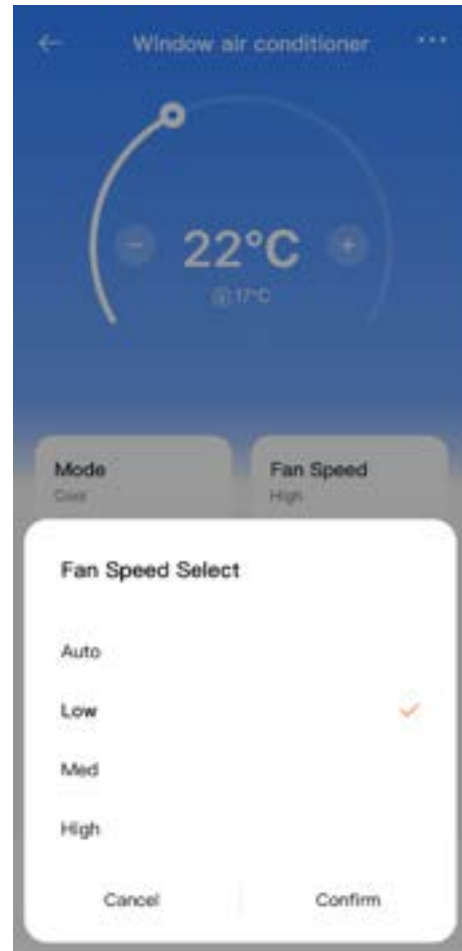
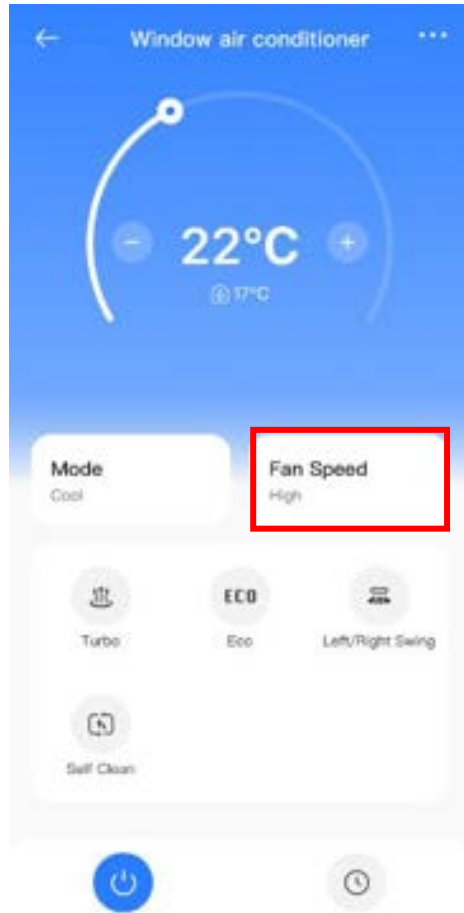

9. Click the [Speed] button to select Auto, Low Medium and High wind speed. Please refer to the operation and installation manual and installation instructions for explanations of each mode.



"Shun Hing Group" Mobile App Operation Manual

(Applicable for Rasonic Air Conditioner)

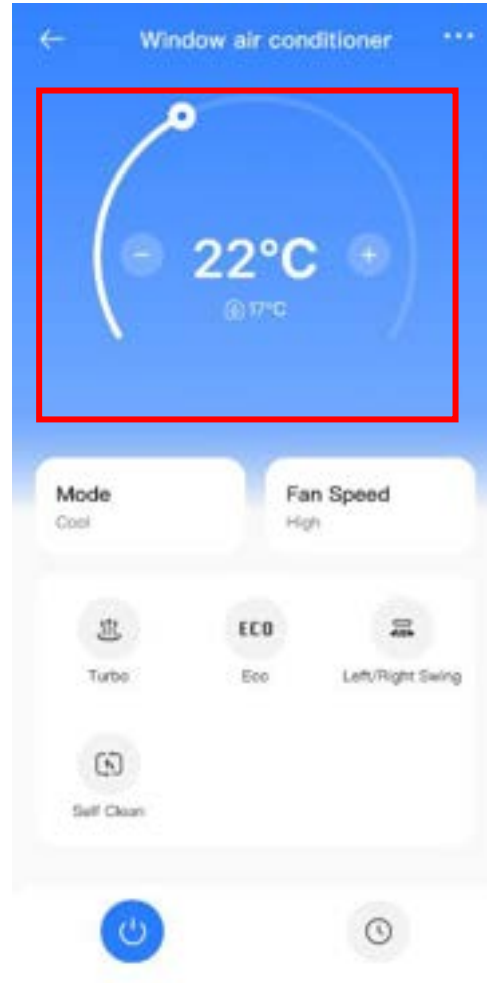

10. Click the [-] or [+] button to adjust or set the desired temperature.
(Temperature cannot be set in [Dry] and [Fan] modes.)



"Shun Hing Group" Mobile App Operation Manual

(Applicable for Rasonic Air Conditioner)

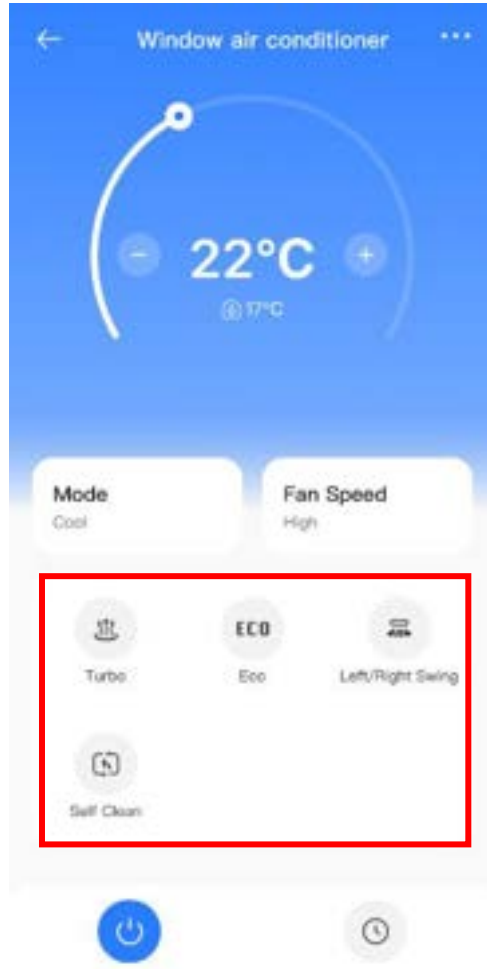

11. Other Functions:

- ① [Turbo] button – Reduce indoor temperature quickly.
- ② [Eco] button – Active energy saving mode.
- ③ [Left/Right Swing] button – Active or stop air swing.
- ④ [Self Clean] button – Active or stop air conditioner's auto clean function.

Please refer to the operation and installation manual and installation instructions for explanations of each mode.



"Shun Hing Group" Mobile App Operation Manual

(Applicable for Rasonic Air Conditioner)



12. Click the [Timer] button in the bottom right corner to set the on or off time for the air conditioner.



"Shun Hing Group" Mobile App Operation Manual

(Applicable for Rasonic Air Conditioner)

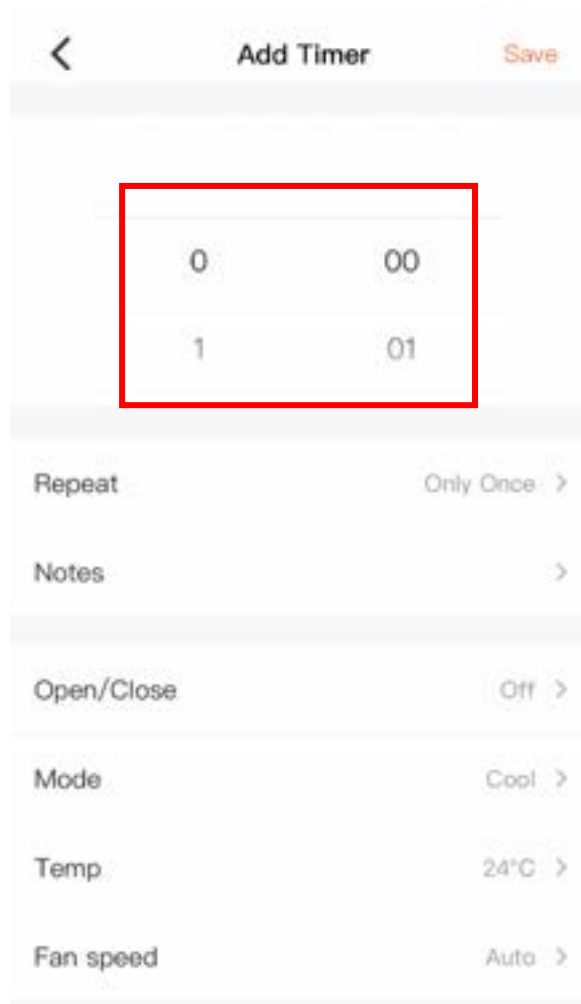

13. After clicking the [Timer] button, please follow these steps to set up:
- ① Set the hour (left) and minute (right).



"Shun Hing Group" Mobile App Operation Manual

(Applicable for Rasonic Air Conditioner)

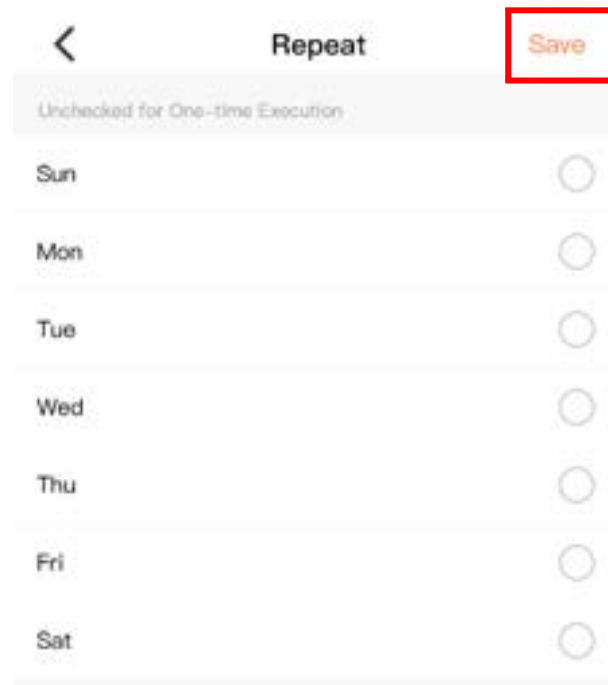
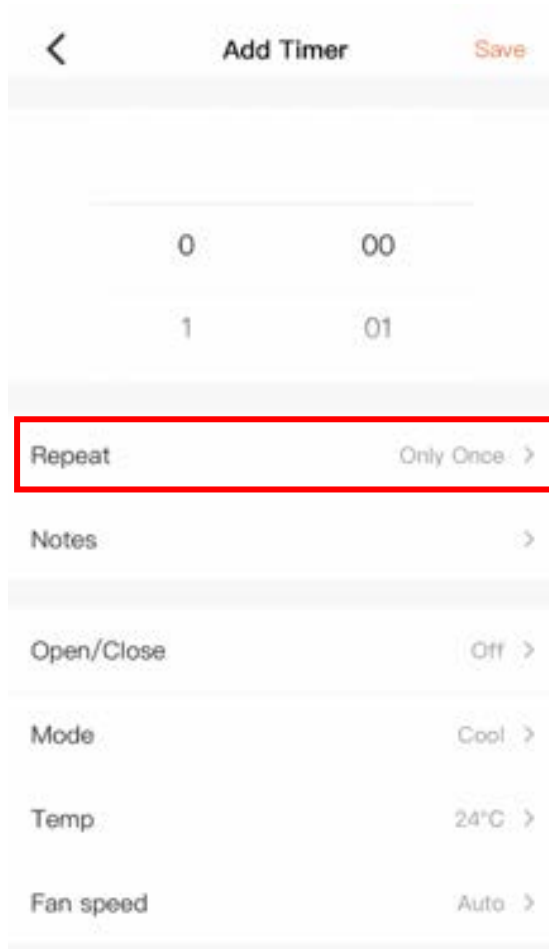

- ② Click the [Repeat] button to set the air conditioner's on/off time to repeat at a specified time each week or to execute only once. After selecting, click the [Save] button to save the settings. °



"Shun Hing Group" Mobile App Operation Manual

(Applicable for Rasonic Air Conditioner)

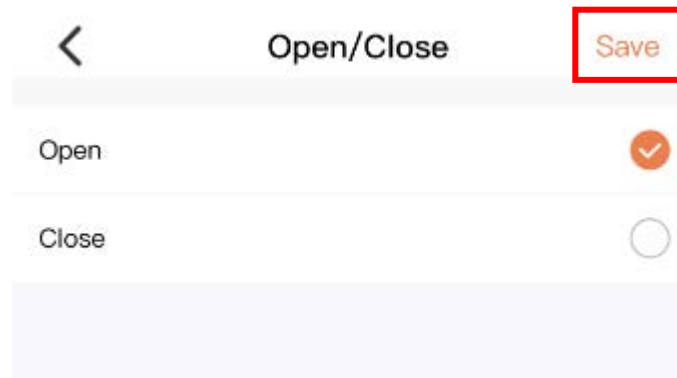
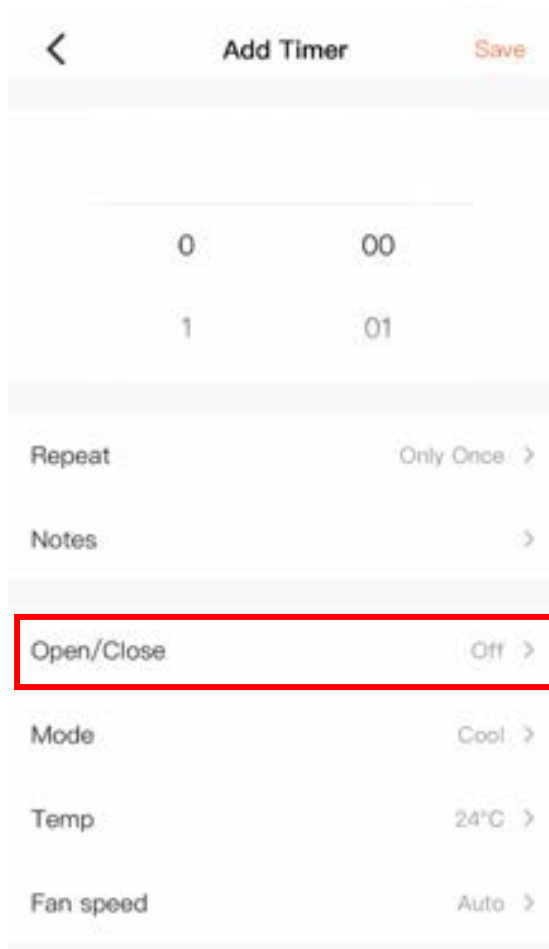

- ③ Click the [OnOff] button, select on or off timer to turn off the air conditioner, and then press the [Save] button to save the settings.



"Shun Hing Group" Mobile App Operation Manual

(Applicable for Rasonic Air Conditioner)

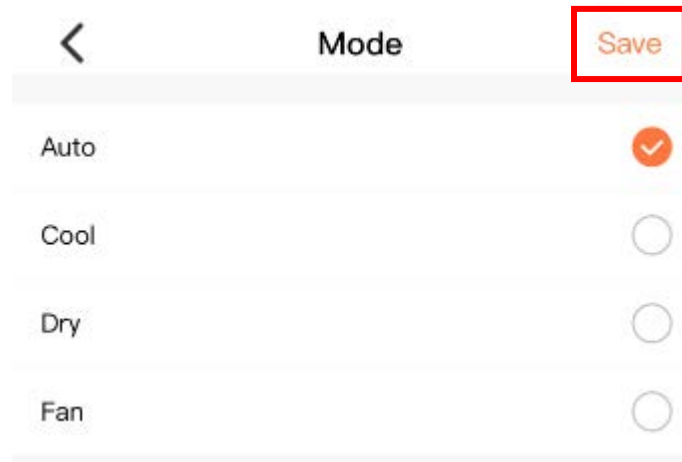
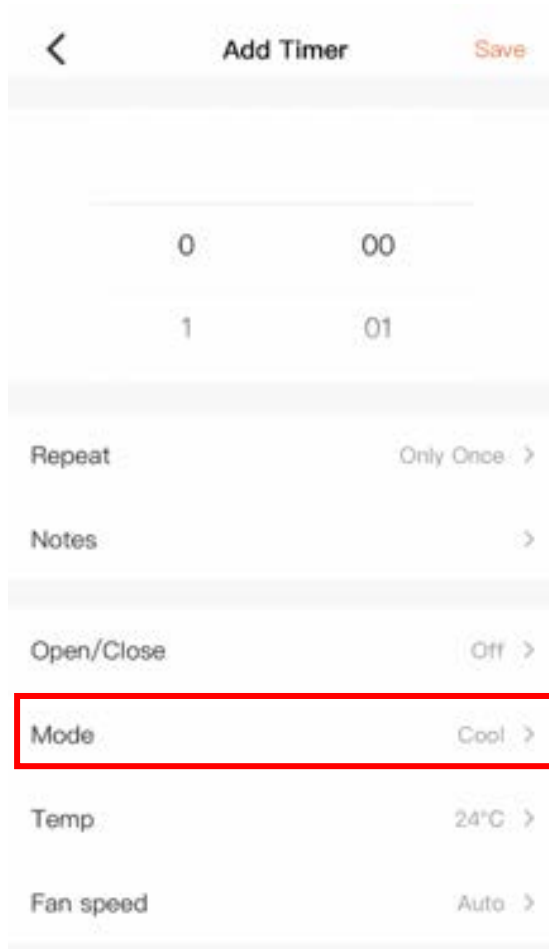

- ④ Click the [Mode] button, select the mode for scheduled startup, and then click the [Save] button to save the settings. °



"Shun Hing Group" Mobile App Operation Manual

(Applicable for Rasonic Air Conditioner)

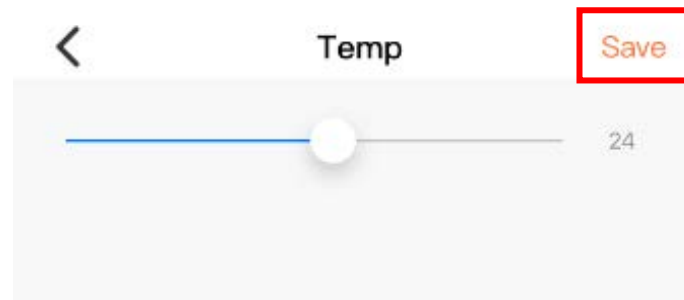
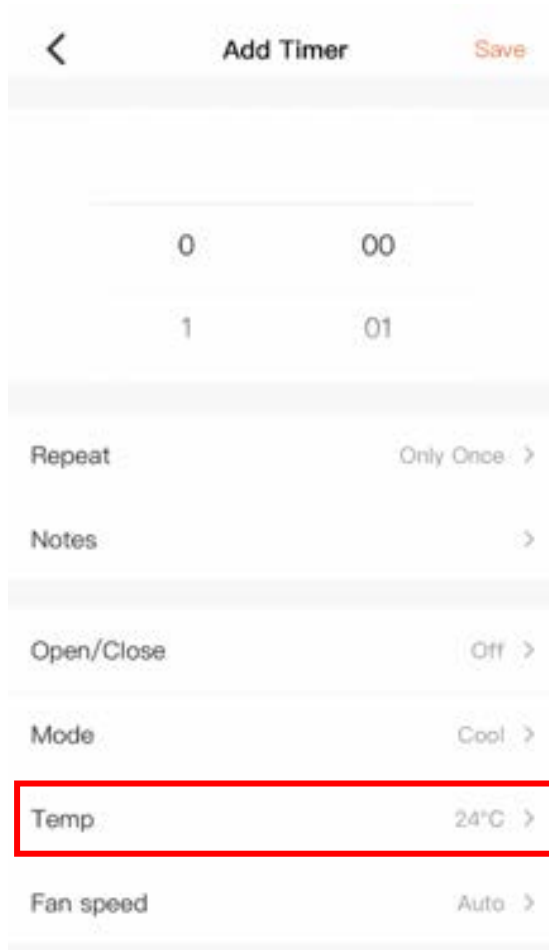

- ⑤ Click the [Temperature] button, select the set temperature for timed start, and then click the [Save] button to save the settings.



"Shun Hing Group" Mobile App Operation Manual (Applicable for Rasonic Air Conditioner)

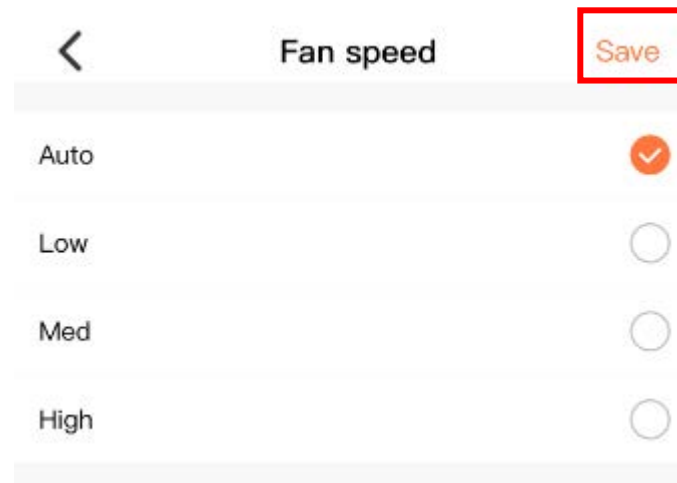

- ⑥ Click the [Fan Speed] button, select the desired fan speed for timed start, and then click the [Save] button to save the settings. °



"Shun Hing Group" Mobile App Operation Manual

(Applicable for Rasonic Air Conditioner)



- ⑦ After setting, click the [Save] button to save the timer on or timer off settings.



"Shun Hing Group" Mobile App Operation Manual (Applicable for Rasonic Air Conditioner)

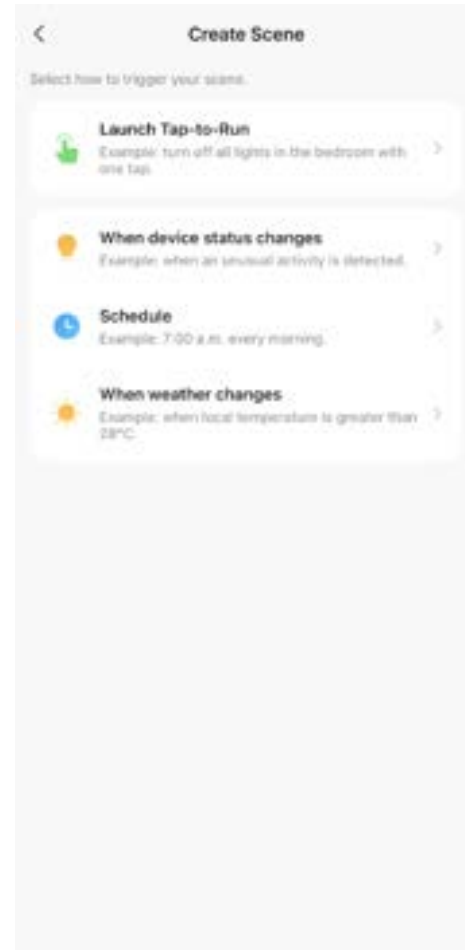
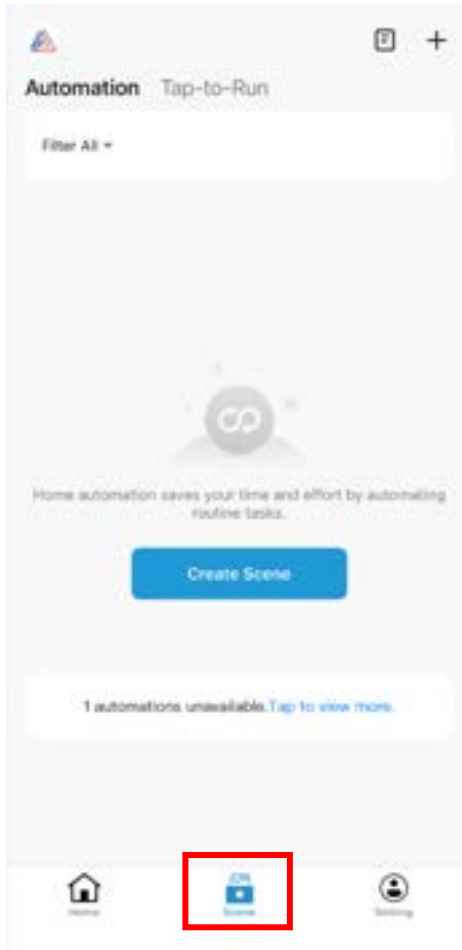

14. Create Scene:
Click on the [Scene] button in the center at the bottom to enter the [Create Scene] settings page, where you can set commands to execute in a specified environment (such as [Schedule], [When weather changes], etc.). °

Note :

- Weather change information and data are provided by a third party.
- There is usually a 10-15 minute delay in executing the command. °



"Shun Hing Group" Mobile App Operation Manual (Applicable for Rasonic Air Conditioner)

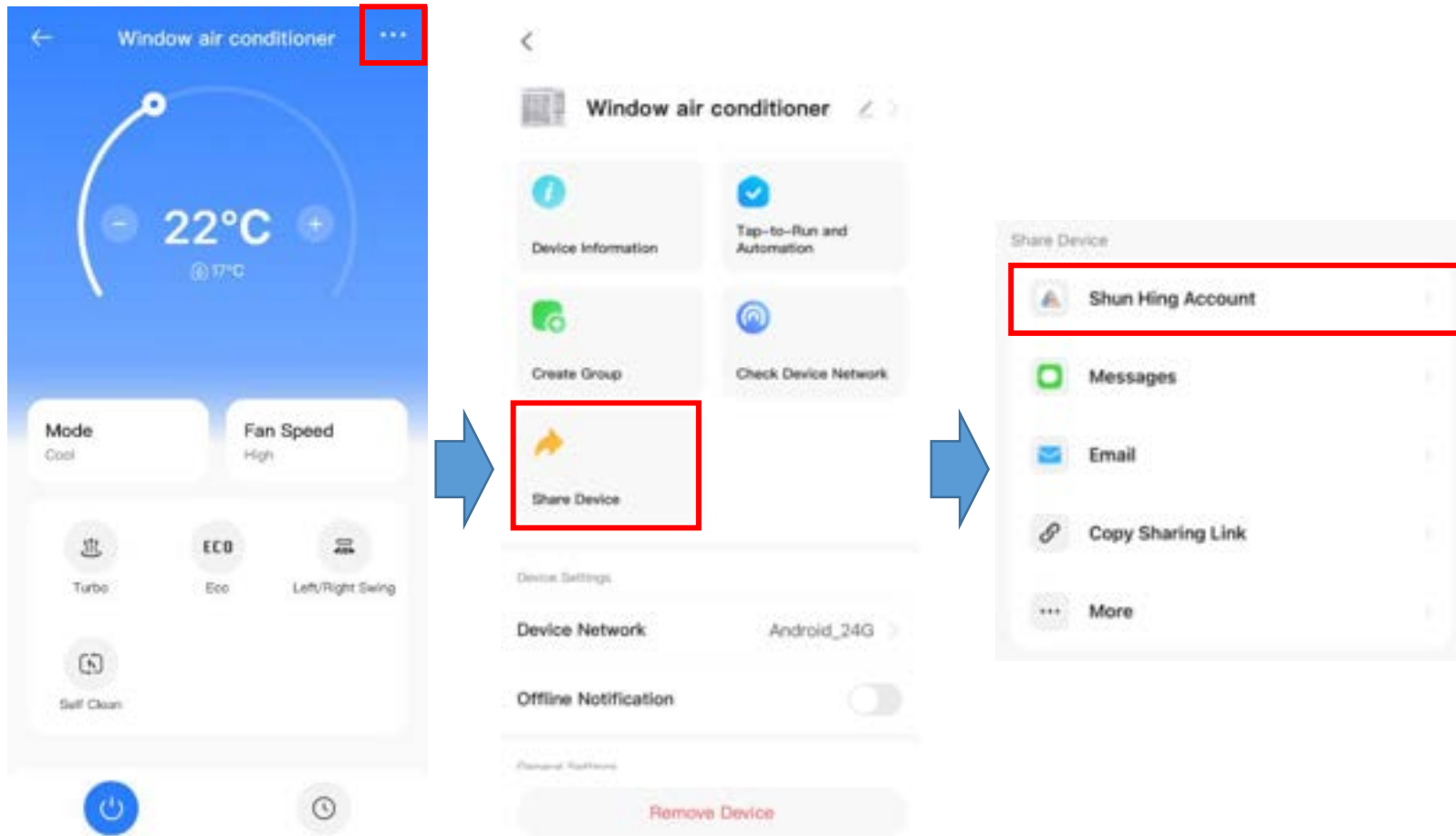

15. Sharing Device:
Click the [...] button in the upper right corner to enter the settings page, then click [Share Devices], and then click [Shun Hing Account] to input registered email address. After the account added, multiple people can control the device. °

Note :

- Only the primary user of this device can use the sharing function. Users who are being shared with must register and log in to the Shun Hing Group mobile app; otherwise, they will not be able to use the sharing function;
- The maximum number of people allowed on the shared device is 20.



"Shun Hing Group" Mobile App Operation Manual (Applicable for Rasonic Air Conditioner)

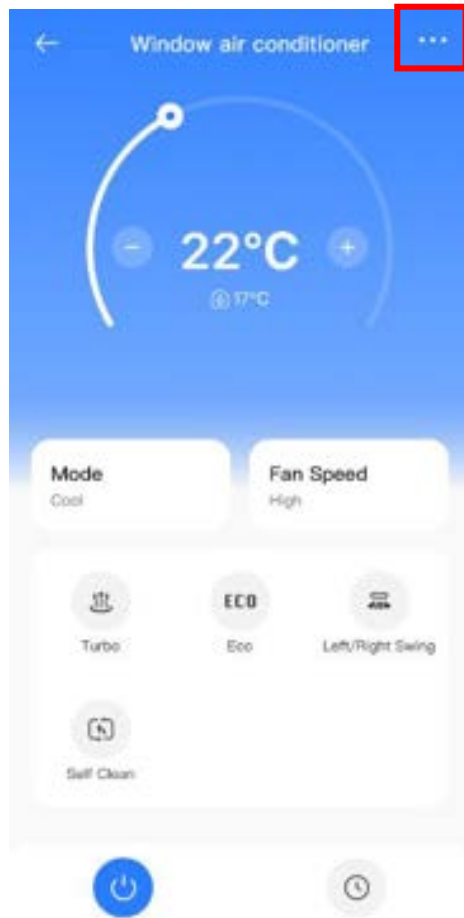

16. Remove Device:

Click the [...] button in the upper right corner to enter the settings page, then click "Remove Device" to remove the device. After confirming removal, the device needs to be restarted and reconnected to the "Shun Hing Group" mobile app.



"Shun Hing Group" Mobile App Operation Manual

(Applicable for Rasonic Air Conditioner)

Rasonic 樂信牌

信興電工工程有限公司

SHUN HING ELECTRIC WORKS & ENGINEERING CO., LTD

辦公室: 香港九龍尖沙咀東部麼地道67號半島中心9樓

OFFICE: 9/F, PENINSULA CENTRE, 67 MODY ROAD,

TSIMSHATSUI EAST, KOWLOON, HONG KONG

電話 TEL: (852) 2861 2767 傳真 FAX: (852) 2865 6706

網址 WEBSITE: www.shew.com.hk

電郵 EMAIL: shew@shunhinggroup.com

保養及維修 **MAINTENANCE AND REPAIR SERVICE**

信興電器服務中心有限公司

SHUN HING ELECTRIC SERVICE CENTRE LTD.

辦公室: 香港新界葵涌勝耀街2號信興中心11樓

OFFICE: 11TH FLOOR, SHUN HING CENTRE, 2 SHING YIU STREET, KWAI CHUNG, NEW

TERRITORIES, HONG KONG

電話 TEL: (852) 2406 5666

傳真 FAX: (852) 2408 0316

網址 WEBSITE: www.shesc.com

消耗品/附件銷售熱線 CONSUMABLES/ ACCESSORIES SALES HOTLINE

電話 TEL: (852) 2406 5666

客戶服務中心 **CUSTOMER SERVICE CENTRES**

香港新界葵涌勝耀街2號信興中心1樓

1ST FLOOR, SHUN HING CENTRE, 2 SHING YIU STREET, KWAI CHUNG, NEW TERRITORIES, HONG KONG

電話 TEL: (852) 2406 5439

傳真 FAX: (852) 2408 1389

澳門慕拉士大馬路149號激成工業大廈(第一期)2樓F座

Avenida de Venceslau de Morais, No. 149, 2 andar - F, Edf, Industrial Keck Seng (Bloco 1), Macau

電話 TEL: (853) 2836 2928

傳真 FAX: (853) 2833 6405

有關最新之客戶服務中心資訊, 請參閱信興服務中心網址 www.shesc.com 或致電維修服務熱線查詢。

For the latest information of customer service centres, please visit www.shesc.com or call us at our hotline.